

File: C:\CYPRUS\JUL17-AM SUPER PARTS\CWG sheet_10/04/01 06:48 by PS0942

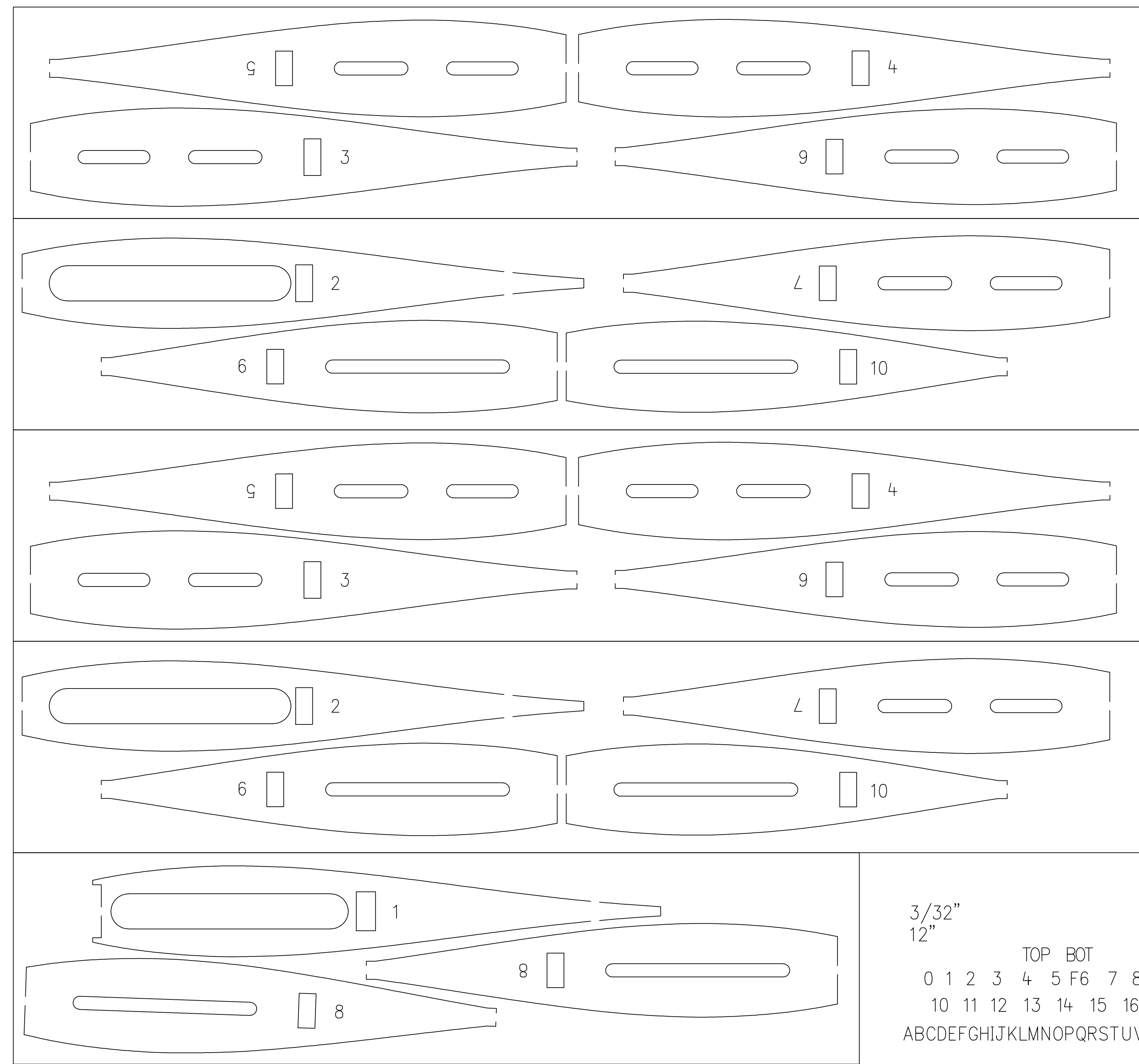

3/32"
16"

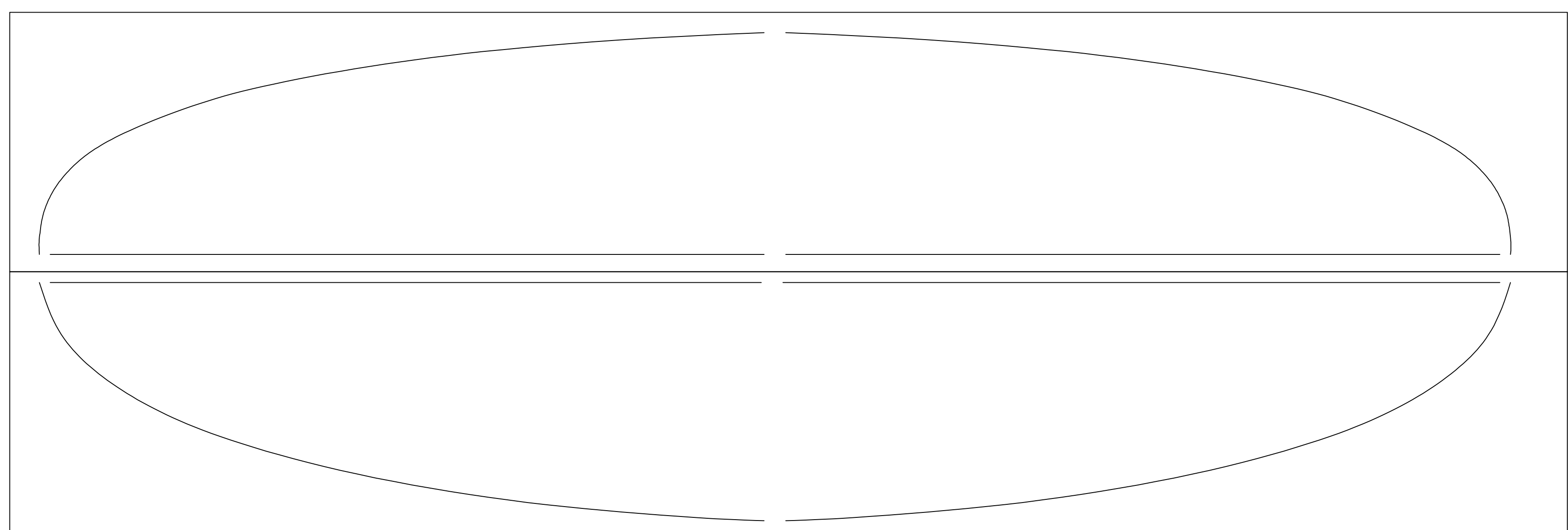

3/16"
18"

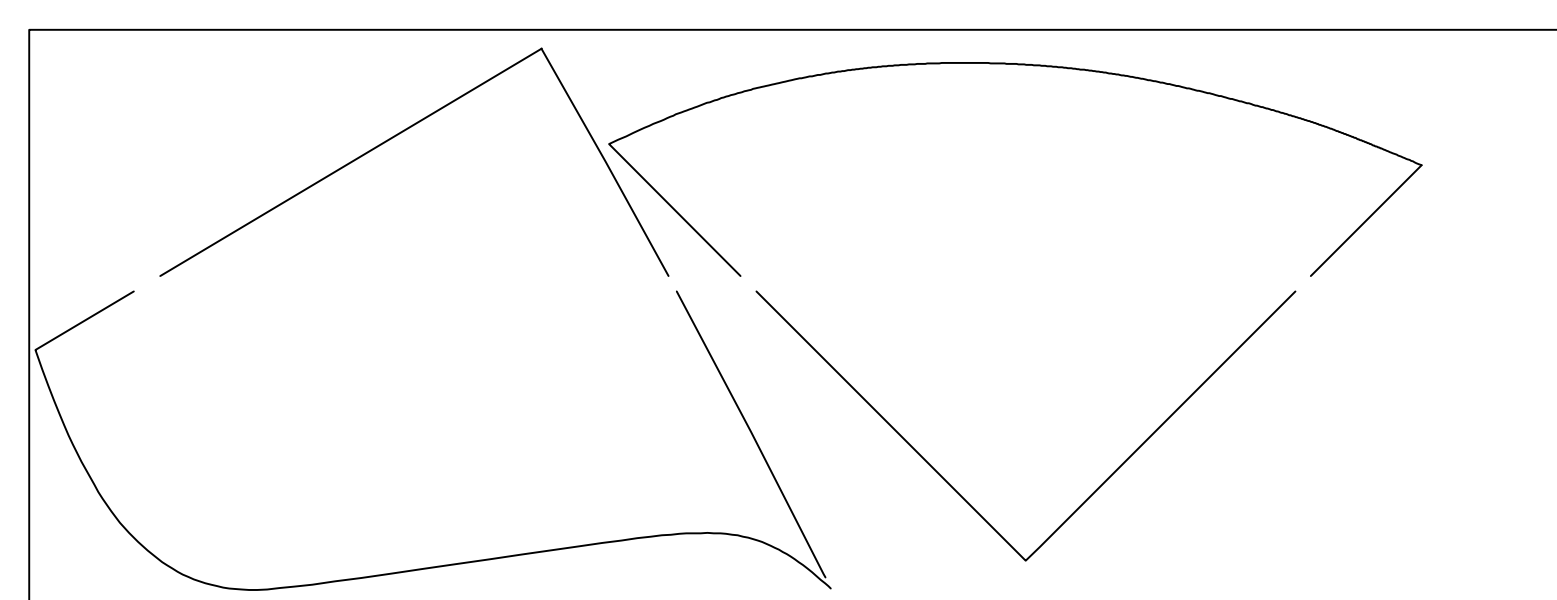

3/16"
8"

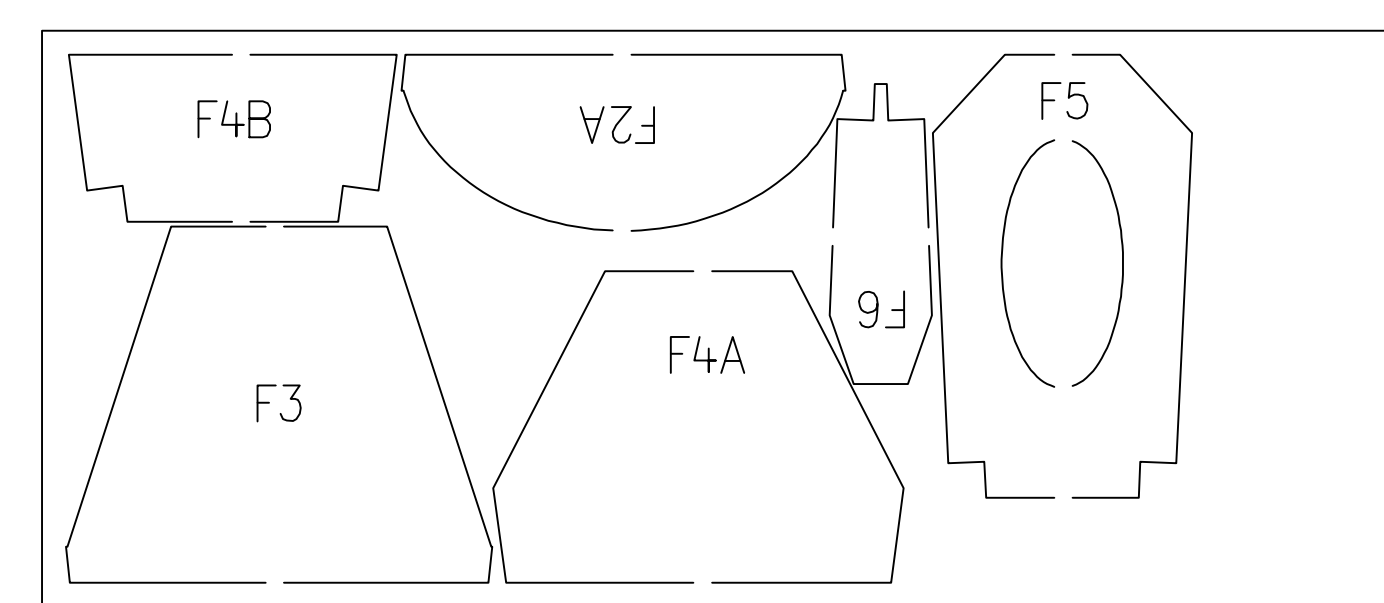

1/8"
7"

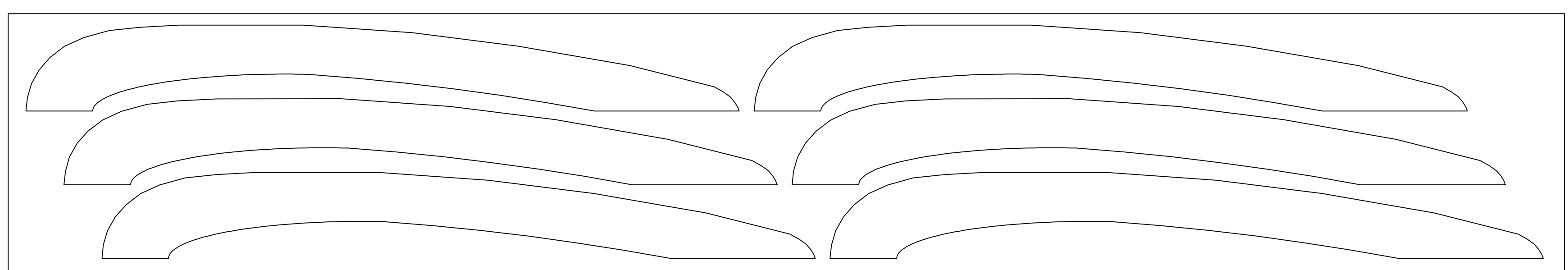

3/16"
18"

3/8"
18"

3/32"
12"
TOP BOT
0 1 2 3 4 5 F6 7 8 9
10 11 12 13 14 15 16
A B C D E F G H I J K L M N O P Q R S T U V W X Y Z

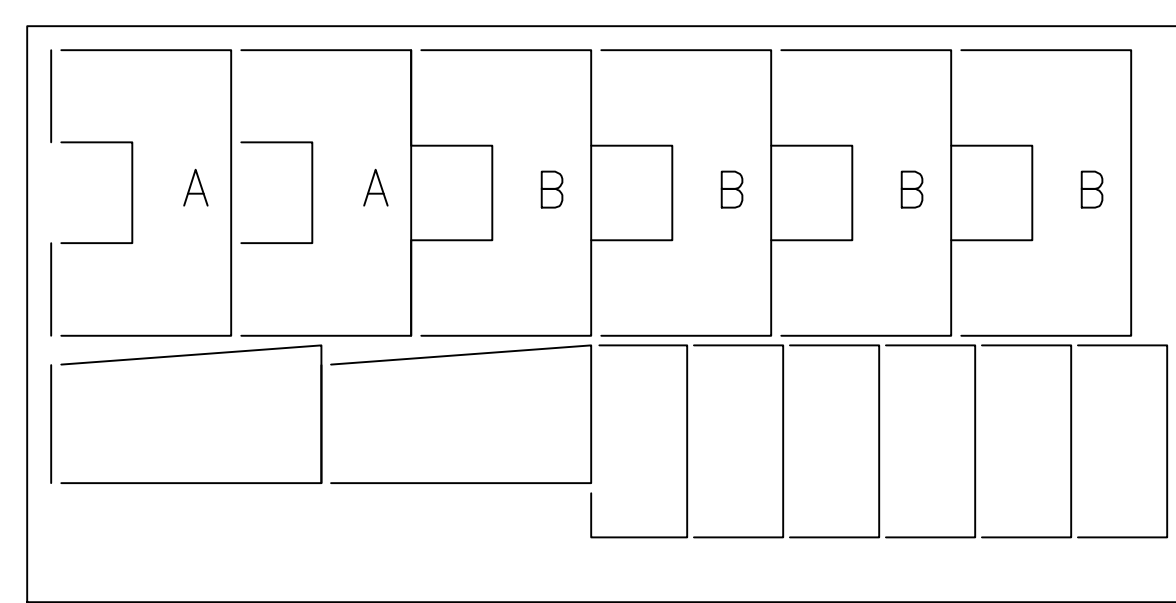

1/4"
6"

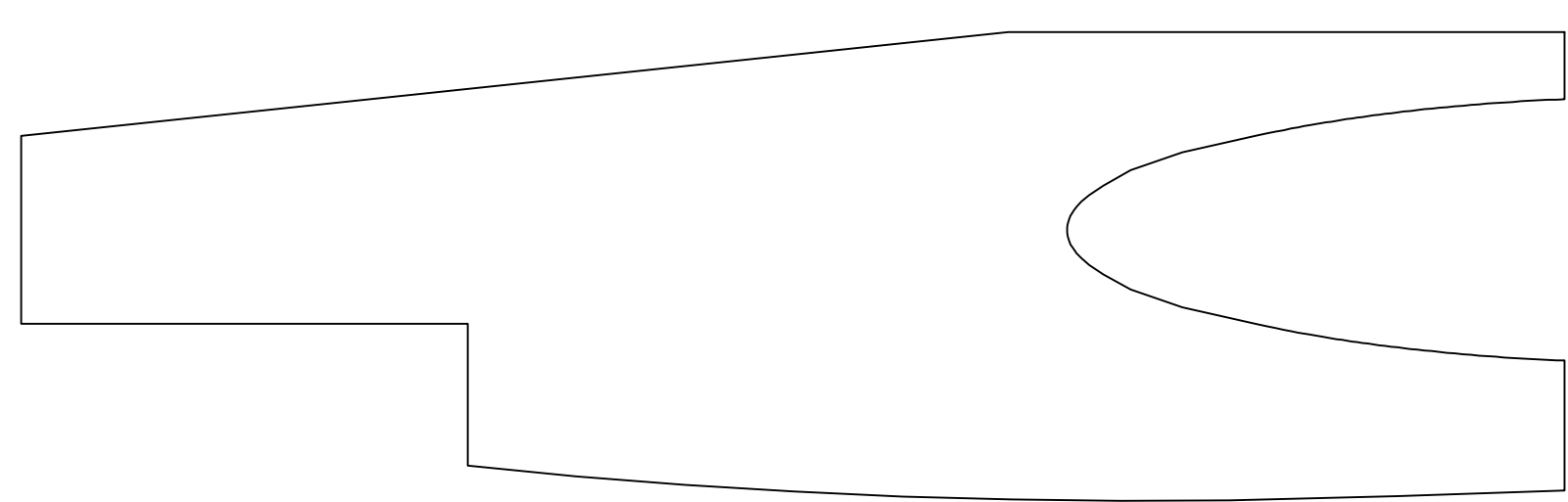

1/32" PLYWOOD DOUBLER PATTERN

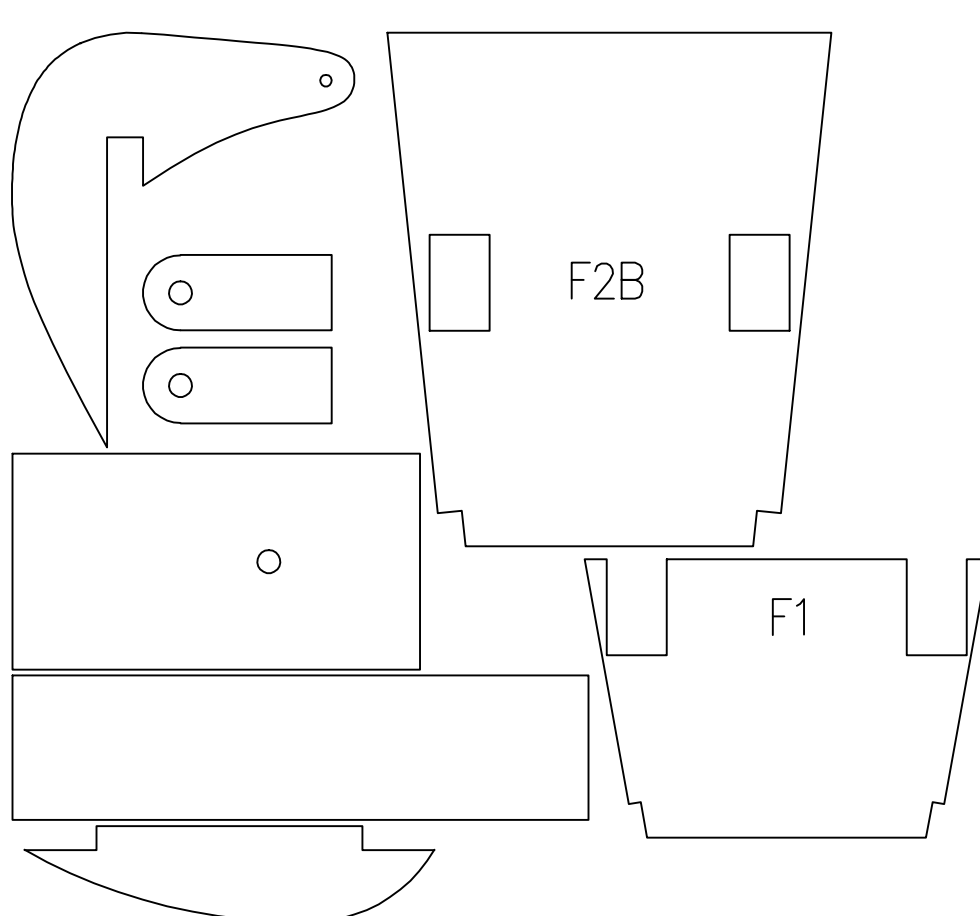

1/8"
LITE-PLY

SUPER RINGMASTER

STERLING KIT S-6
BY MATT KANIA
ACAD by PAT JOHNSTON 8-31-09
381 SQ. IN. 25 ENGINES
24 OZ. W/ OS 25LA

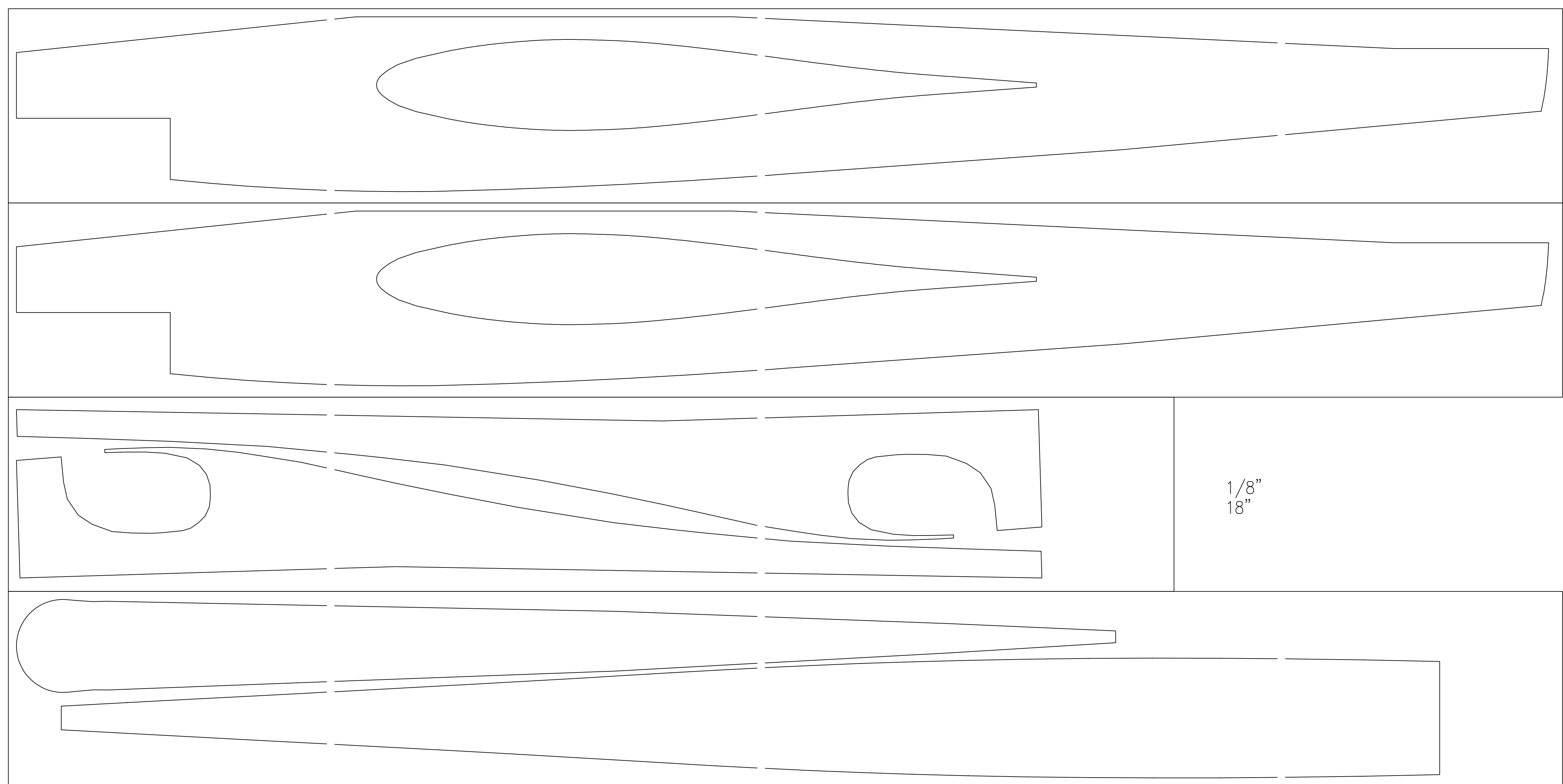

1/8"
24"

1/8"
18"

1/8"
24"